







**Industrial-grade  
performance.  
Reliable, repeatable  
results.**

- Achieve more with FDM 3D printing
- Built for the factory floor
- A future-proof investment





 **UltiMaker Factor 4**

# The application solution for manufacturing operations

## Target applications

-  Small batches of auxiliary components
-  Manufacturing aids including jigs, fixtures, and assembly tools
-  Durable spare, bridge, and service parts for real working conditions
-  Functional engineering prototypes

## New hardware features

-  Dual extrusion direct drive print head
-  Actively controlled build volume temperature
-  Effective build volume of 330 x 240 mm in XY
-  Automated material handling system with low relative humidity storage





## Materials

 14+ UltiMaker materials with NFC recognition

 Widest choice of 200+ profiled materials on UltiMaker Marketplace





 Including flexible, low Shore A thermoplastic elastomers

 Plus composites, mid-high temperature polymers, and stainless steel

## Software

 Powered by the UltiMaker Cura

 UltiMaker Digital Factory for secure printer management, file storage, and analytics

 Onboard print process reporting for part validation and structural integrity verification

 Integration with industry-leading software solutions



## Service

 Highly modular design for fast and easy repairs

 Achieve high uptime with UltiMaker Extended Service policies through UltiMaker customer support agents and our network of service providers

# Accurate applications from design to industrial

UltiMaker Factor 4 is our end-to-end industrial application solution. It's tailored for the development, production, and full-confidence deployment of process-critical tools and machine components.

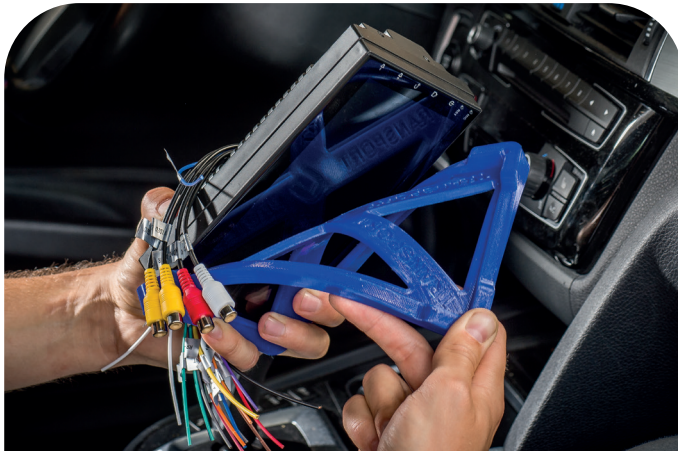

## Manufacturing tools that streamline production

When you need to keep operations running, Factor 4 can help simplify factory processes and reduce human-related inconsistencies. It facilitates operations with direct dual material extrusion, support for engineering materials, and onboard print process reporting to achieve unrivaled predictability and minimal variance.

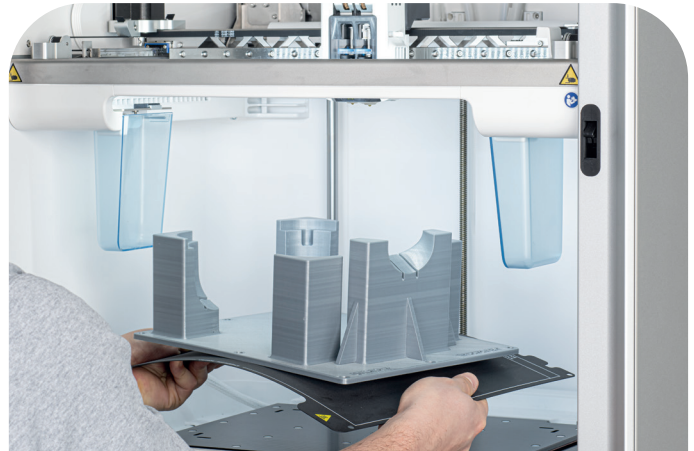

## High-fidelity functional engineering prototypes

The ability to accurately reproduce functional parts in a wide variety of engineering materials accelerates testing and innovation. Factor 4 is a low-emission, low-maintenance platform that's safe to leave unattended. Stay in full control with over 400 Cura settings and in-depth part validation tools.

## Small batches of auxiliary end-parts

Factor 4 delivers predictable, verifiable part quality for distributed production. The less than 10% variance in extrusion rate and mechanical properties, plus the repeatable dimensional accuracy batch after batch, is a combination of the H-bridge gantry, closed loop feed control, and uniformly controlled build plate temperatures – with a maximum variation of 5°C across the X and Y axes.



# Innovation powered by material diversity

UltiMaker PPS-CF is a new high-temperature composite for Factor 4 that can replace complex steel parts. Its heat deflection temperature is greater than 230 °C. It's chemical resistant and flame retardant (UL94 V0), making it a versatile choice for demanding applications.

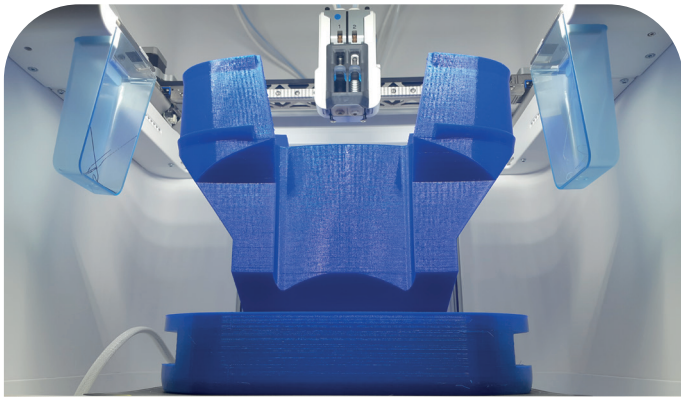
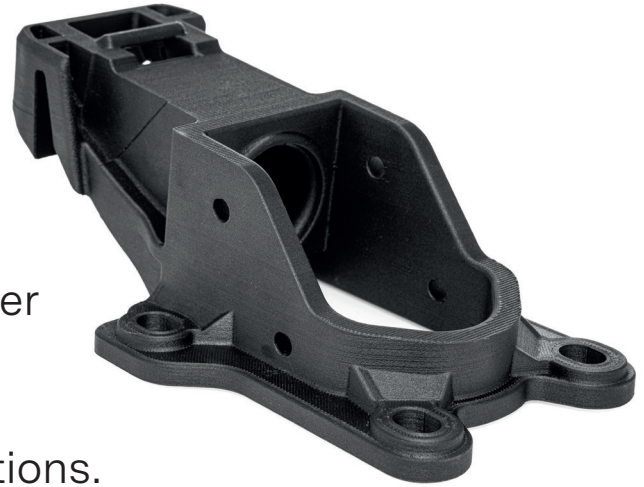

## Large flexible parts in TPU 95A to TPU 70A

Flexible materials down to Shore 70A means you can reliably protect parts from damage and create gaskets, seals, and shock absorbers.

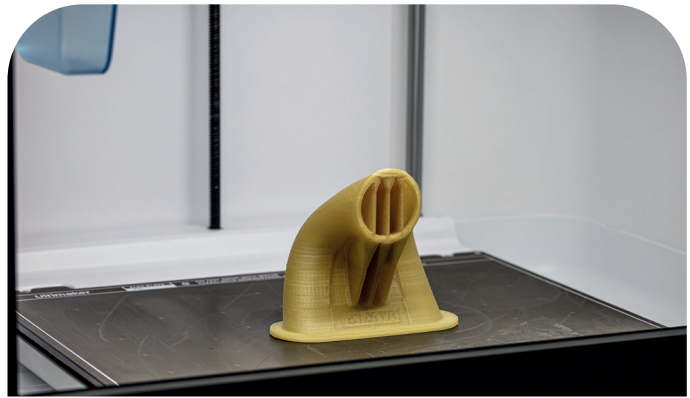

## Access to 200+ Marketplace materials

A wide range of high-performance and certified material properties opens up a huge range of new 3D printing applications on Factor 4.

# Repeatable results with high print success



## Edge-to-edge dual extrusion

3D print with confidence across every millimeter of the 330 x 240 mm flexible build plate. And quickly remove parts thanks to its PEI coating.

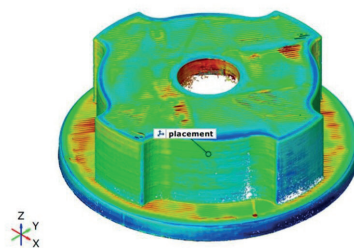

## Tested for accuracy

We have verified dimensional accuracy within  $\pm 0.2$  mm or  $\pm 0.2$  % nominal length over the full printer build volume using PPS CF, PET CF, Tough PLA, and PETG.

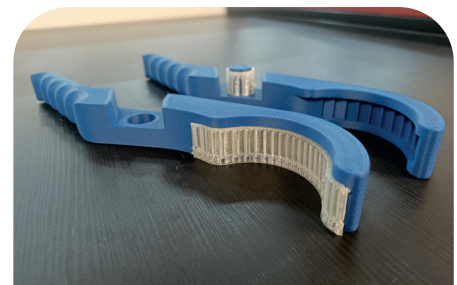

## Accelerated design freedom

Leverage the full power of additive manufacturing with fast dual printing capabilities for complex geometries and multimaterial parts.

# Packed with technology for maximum predictability

## Fully redesigned extrusion train

The combination of the all-new H-bridge gantry and direct drive extrusion print head allows high-speed movement and positional accuracy of  $\pm 0.2$  mm or  $\pm 0.2\%$  of the feature's nominal length with UltiMaker Verified Materials. This results in best-in-class dual material printing speeds so that you can quickly create the flexible or strong parts you need.



## Hassle-free material handling

A new, integrated, automatic material handling system reliably manages your spools so you don't have to. The internal chamber is kept at less than 10% RH in office conditions, so you can keep up to 6 kilograms of filament in perfect condition for back-to-back print jobs.



## Actively temperature-controlled build volume

UltiMaker Factor 4 raises the temperature up to 340 °C using the HT print core.

This means that you can now 3D print higher temperature-resistant and durable materials with more confidence.

The temperature within the fully enclosed build volume is also controlled up to 70 °C, with a heated bed up to 120 °C, ensuring optimal material-specific processing conditions and consistent part quality wherever the 3D printer is located.

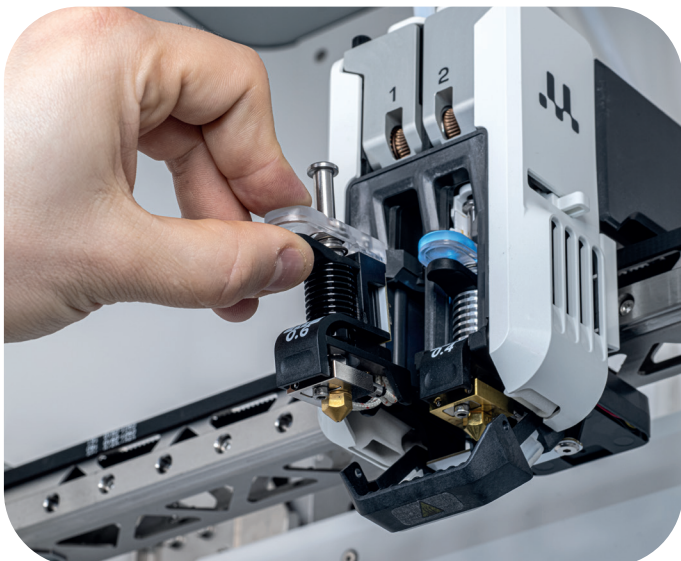
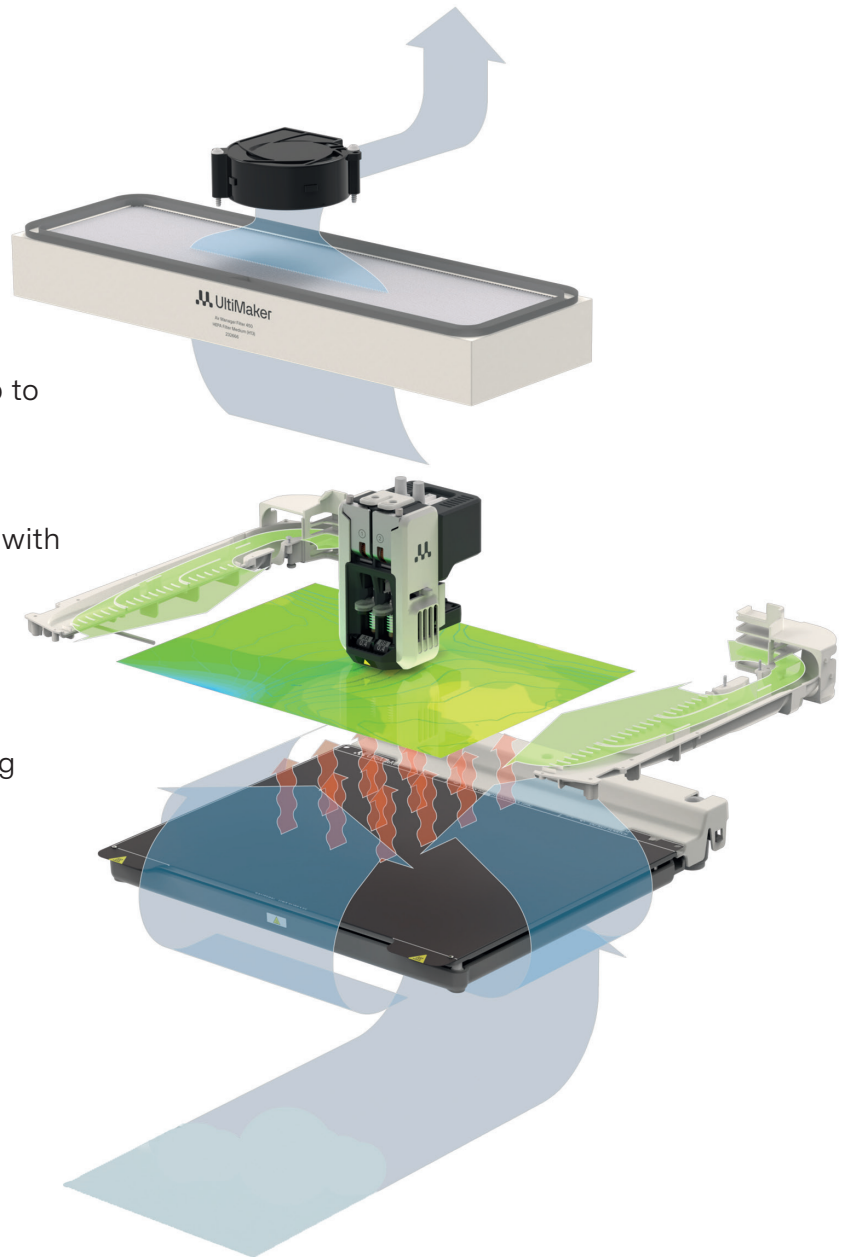

# Seamless software integration

UltiMaker Cura and Digital Factory work together with Factor 4 and UltiMaker materials to provide an easy, secure, and reliable workflow - from 3D model to printed part.

## UltiMaker Cura: Easy print preparation for manufacturing

Our software leads the AM industry with its powerful slicing engine. A variety of file types including native CAD files can be directly imported and quickly sliced with pre-tuned application intent profiles. Cura also features:

- Over **400** settings to make granular adjustments
- Material interlocking for unrestricted multi-material combinations
- Sequential printing, ideal for small-batch production
- Regular updates that constantly improve the printing experience

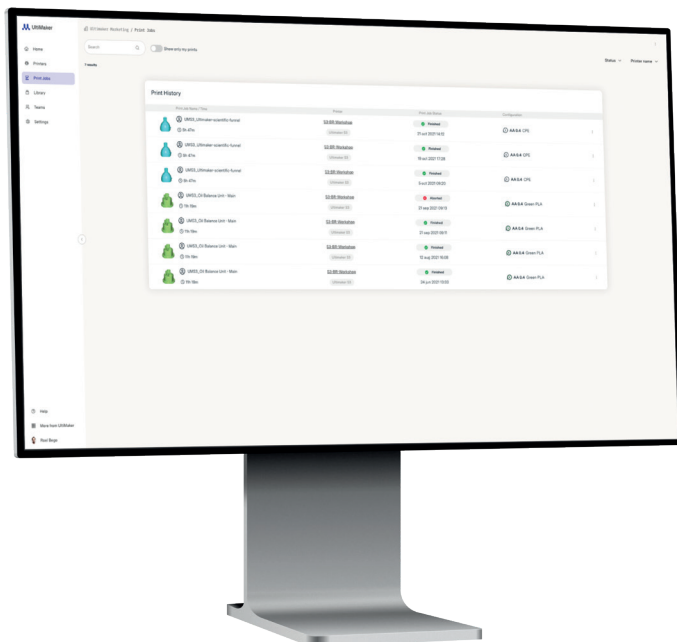
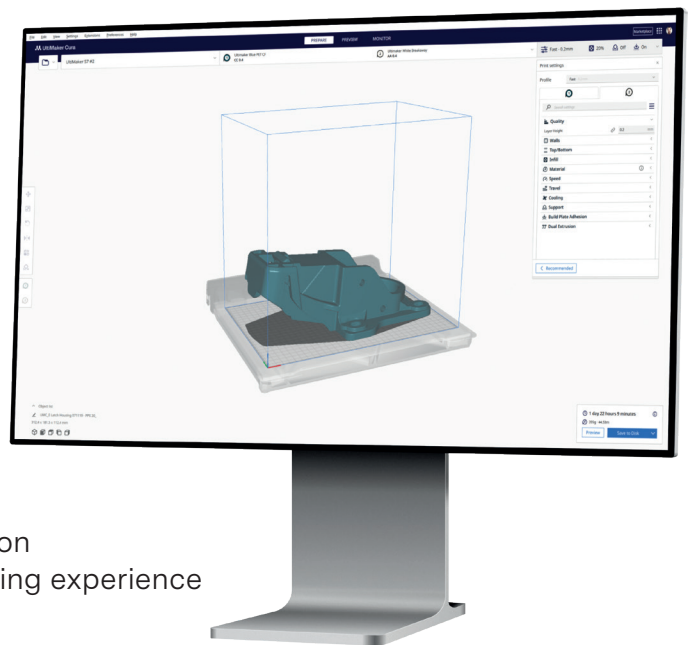

## UltiMaker Digital Factory: Secure, efficient 3D printing management

With shared workspaces, assigned roles, and file management using the digital library, coordinating your printing schedule is simple. The live HD camera feed on every Factor 4 combined with progress and status updates makes it trivial to handle multiple prints on multiple printers with zero downtime. Digital Factory also includes:

- In-depth analytics for review and forecasting (with CSV export)
- An overview and history of printer maintenance tasks
- Secure remote control to reprint jobs without reslicing



## Onboard structural integrity validation

After every print job, receive an in-depth report on extrusion parameters deviations from nominal values, their locations, and their severity in the 3D model. Using a suite of sensors in the print head, build chamber, and material loading system, this print process reporting helps to verify and validate part quality before use in the field.

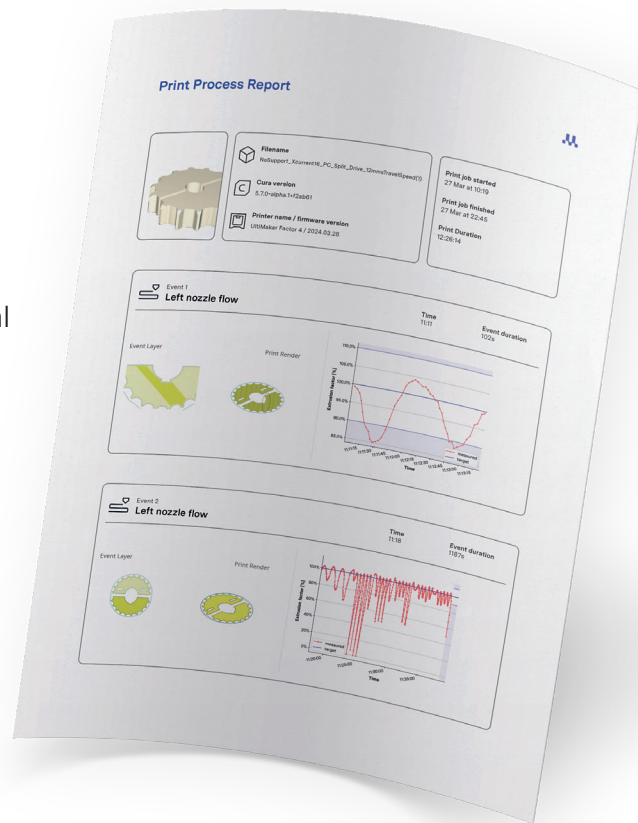

## Modularity at your service

UltiMaker Factor 4 was designed to be modular. This means less production downtime in the event that a part of the printer needs servicing. Under the UltiMaker Factor 4 service plans, an expert technician anywhere in the world will be able to quickly swap the faulty part out for another so you can get up and running again as quickly as possible.



# Application and material-matching print cores

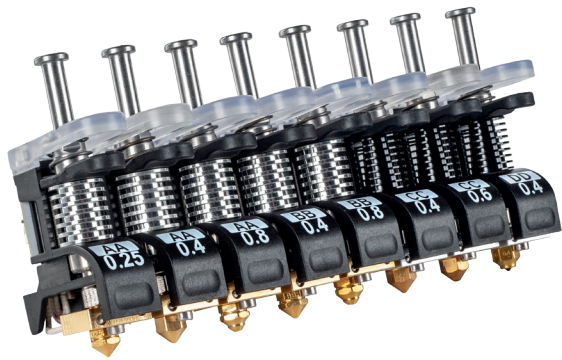

UltiMaker print cores feature a quick-swap design and EEPROM chip. They are recognized by Cura and can be quickly changed without tools to meet the requirements of any print job, increasing your efficiency and decreasing downtime.

Type	Nozzle sizes	Max. temp	Materials
AA	0.25, 0.4, 0.8	280°C	Up to Polyamides 6, TPU, PC, ABS, PETG
BB	0.4, 0.8	280°C	PVA and other water soluble materials
CC	0.4, 0.6	300°C	Composites, metal
DD	0.4	280°C	Ultrafuse support layer, Ceramics
HT	0.6	340°C	High-temp composites, PPS CF, PEKK-A

## A safe and functional printer station to support Ultimaker Factor 4

### Increased ease of use

- Easy and safe access to printer rear side for maintenance and repair
- Safe displacement and transport
- Minimal floor occupancy

### Built-in safety

- Tailor-made for Factor 4
- Anti-tilting architecture and stability tailored for Factor 4
- Lock in mechanisms to fix printer to cabinet

### Ergonomically designed

- Perform operations at right height and comfort
- Store 18 spools and accessories with lockable drawers



## UltiMaker Factor 4 specifications

<b>Printing properties</b>	Technology	Fused deposition modeling (FDM)
	Extrusion system	Dual-extrusion, direct drive print head with unique auto-nozzle lifting system and swappable print cores
	Build volume	Single material printing: 330 x 240 x 300 mm (13 x 9.4 x 11.8 in) Dual material printing: 330 x 240 x 300 mm (13 x 9.4 x 11.8 in)
	Filament diameter	2.85 mm
	Print profiles availability	14+ UltiMaker materials 200+ UltiMaker Marketplace materials
	Dimensional accuracy	±0.2 mm ±0.2% feature nominal length. For detailed conditions visit <a href="https://ultimaker.com/factor4">ultimaker.com/factor4</a>
	<b>Hardware properties</b>	XYZ resolution
Homing sensor		Optical
Build plate		PEI-coated flexible build plate
Build plate temperature		Up to 120 °C
Build volume temperature		Actively controlled up to 70 °C with nozzle plane temperature uniformity within: ±3 °C for temperatures < 50 °C ±5 °C for temperatures < 70 °C
Extrusion flow		Closed loop flow compensation
Max. extrusion temperature		280 °C: Print core AA, BB, DD 300 °C: Print core CC 340 °C: Print core HT
Compatible print cores		Print core AA (0.25 mm, 0.4 mm, 0.8 mm) Print core BB (0.4 mm, 0.8 mm) Print core CC (0.4 mm, 0.6 mm) Print core DD (0.4 mm) – available in selected regions Print core HT (0.6 mm)
Closed loop fans		Air filtering fan, air recirculation fans, print cooling fans, print core cooling fan
Material handling capacity		6 bays with NFC recognition (max. 1 kg spool size)
Material humidity control		Average relative humidity < 15% in all operational conditions
Filtration system		HEPA H13
Emission rate (UFP & VOC)		UltiMaker filaments below limits listed in UL-2904
Monitoring		HDR (high dynamic range) 1920 x 1080 px HD camera
Display		7-inch touchscreen (resolution 1024 x 600 px)
Connectivity		Wi-Fi 2.4 & 5 GHz: IEEE 802.11a/b/g/n/ac LAN: Gigabit Ethernet USB: 2.0
System on module		NXP i.MX8 Mini Quad (4 x 1.8 GHz), ARM Cortex-A53, 2 GB LPDDR4 16 GB eMMC
Real time controller		i.MX RT1064, Arm Cortex-M7 600 MHz, 1 MB SRAM
Power requirement		100 – 240 V AC, 50 – 60 Hz max., 6 A
<b>Physical dimensions</b>		Dimensions
	Weight	120 kg (265 lbs)
	Shipping dimensions	760 x 800 x 1587 mm (30 x 31.5 x 62.5 in)
	Shipping weight	137 kg (309 lbs)
<b>Ambient conditions</b>	Operating sound	< 50 dBA in operation
	Operating environment	Operating: Temperature: 18 °C – 30 °C, humidity: 30 – 70% RH Storage: Temperature: 5 °C – 40 °C, humidity: 20 – 90% RH
<b>Software</b>	Print job preparation	UltiMaker Cura 5.7.1 or newer
	Print job management	UltiMaker Digital Factory
	File types supported	UltiMaker Cura: STL, OBJ, 3MF Printable formats: G, GCODE, UFP, STEP
	System requirement	Windows 7 (64-bit), Mac OS X 10.12, OpenGL 2.1 4 GB RAM (8 GB recommended)
	Print process reporting	Supported
	Security	Active firewall and PIN code settings protection
<b>Safety and compliance</b>	Warranty period	12 months limited warranty
	Certifications	For a detailed list of certifications visit <a href="https://ultimaker.com/factor4">ultimaker.com/factor4</a>
	Safety features	Red stop button immediately stops motion and heat sources Open door sensor pauses motion and extrusion



General inquiries: [info@ultimaker.com](mailto:info@ultimaker.com)  
Phone: +31 (0) 88 383 4000  
Find a local reseller: [ultimaker.com/resellers](http://ultimaker.com/resellers)  
Learn more at [ultimaker.com](http://ultimaker.com)